

PUMP STATIONS & EQUIPMENT



WWW.TARANTIN.COM • 800-922-0724



Download Our App
Order From Anywhere



2021 - 2022



“From our one location in 1983, we have grown to a top-notch company with six locations serving the Eastern US. These achievements could not have been possible without the support of our customers, vendors and employees. As we move forward, we remain steadfast in our commitment to excellence in customer service.”

Backorders













Items not shipped with your original order will be kept on order and shipped as soon as possible unless otherwise specified.

Freight

We ship UPS, FED-EX, USPS, and common carrier. Orders are shipped in the most economical manner. If you have a shipping preference, please indicate when placing your order. Freight terms are FOB origin unless otherwise agreed upon.

Quality

We adhere to strict quality control. Thus, Tarantin guarantees all items to be free of damage upon shipping. Freight damages must be addressed by the appropriate company handling your delivery.

	Pump Stations, Autogas, and Accessories	3
	Pumps	11
	Emergency Shut-off Valves	16
	Meters	17
	Compressors	19
	Cylinders and Storage Cabinets	21
	Tank Anchoring	24
	Cathodic Protection	25
	Tools and Accessories	26
	MOSCAP Gauges	30
	Hose Assemblies and Accessories	31
	Signs and Decals	33
	Carrier Tanks	34

Download Our App
Order From Anywhere



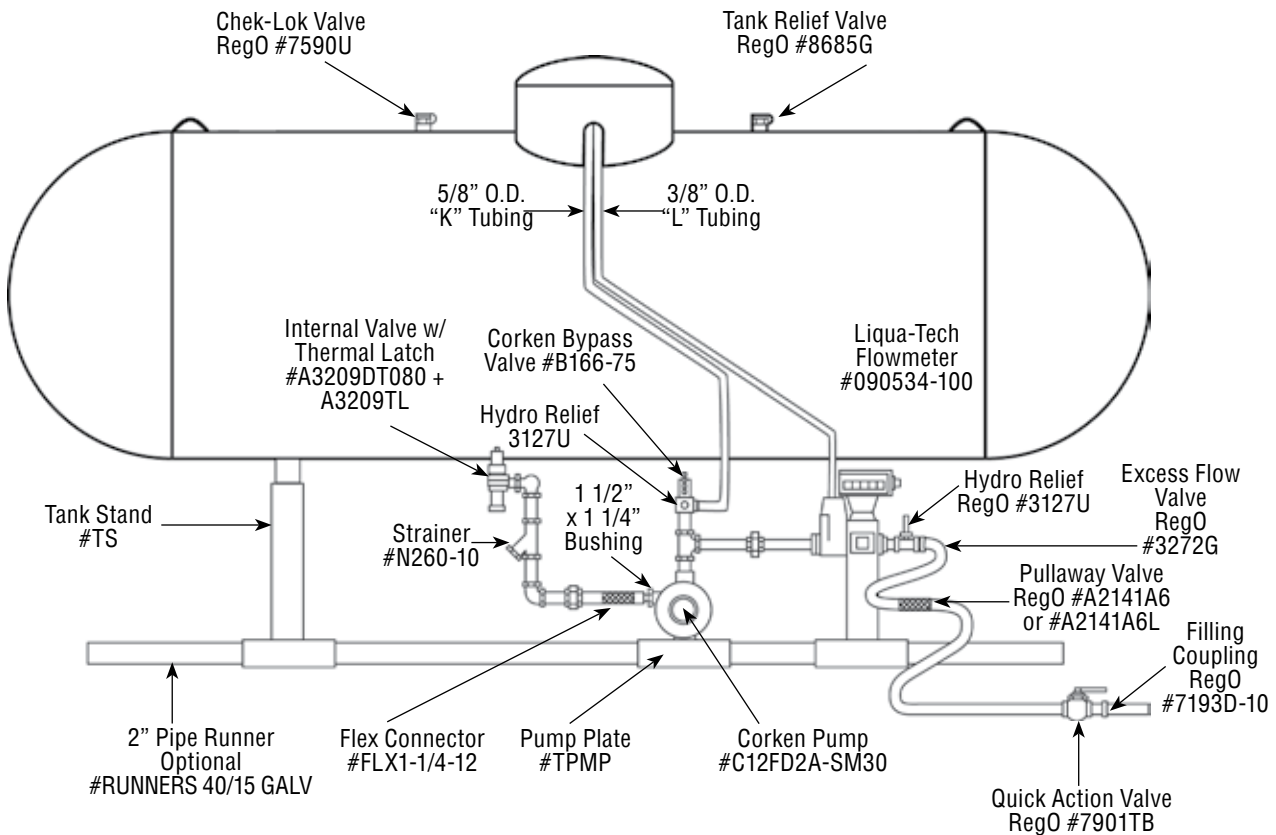

GENERAL INFORMATION FOR PUMPING STATION DESIGN

- Choose the proper size tank for the operation, with a 1,000 gallon tank for a large industrial motor fueling or a 500 gallon tank for a small 20 lb. refilling.
- Always use a tank with a bottom withdrawal, preferably a new one. If a used tank is to be used, remove as many heavy ends as possible.
- Size the pump to the operation. Try to consider future expansion. If a meter is to be used, be sure to use a large enough pump, such as a Corken C12 or large C13.
- Couple the pump to an external by-pass, DO NOT rely on an internal by-pass on the pump.
- If a meter is to be used be sure it is designed for the operation. Use Liqua-Tech LPM102 or Liquid Controls MA4.
- Piping should be the same size as your pumps and meters, never smaller. Schedule 80 pipe and Type K copper tubing is required.
- Safety is a major consideration. Be sure a fire extinguisher and proper warnings and decals are used.



Aluminum Assembled Pump Station Cabinet

D2A-KIT-ALUM



Components Include:

- Cabinet
- Tank Stands (*not pictured*)
- Corken C12 Pump with Switch
- Bypass Valve
- Liqua-Tech Meter
- Scale (*Do not install wheels if placed in cabinet*)
- Piping Kit (*Internal Valve 1/4", Hydrostatic Relief Valve, Angle Valve 3/4", Excess Flow Valve 3/4", Y Strainer, Flex Connector, Forged Steel Fittings, Schedule 80 Nipples, 3/4" Breakaway Coupling*)

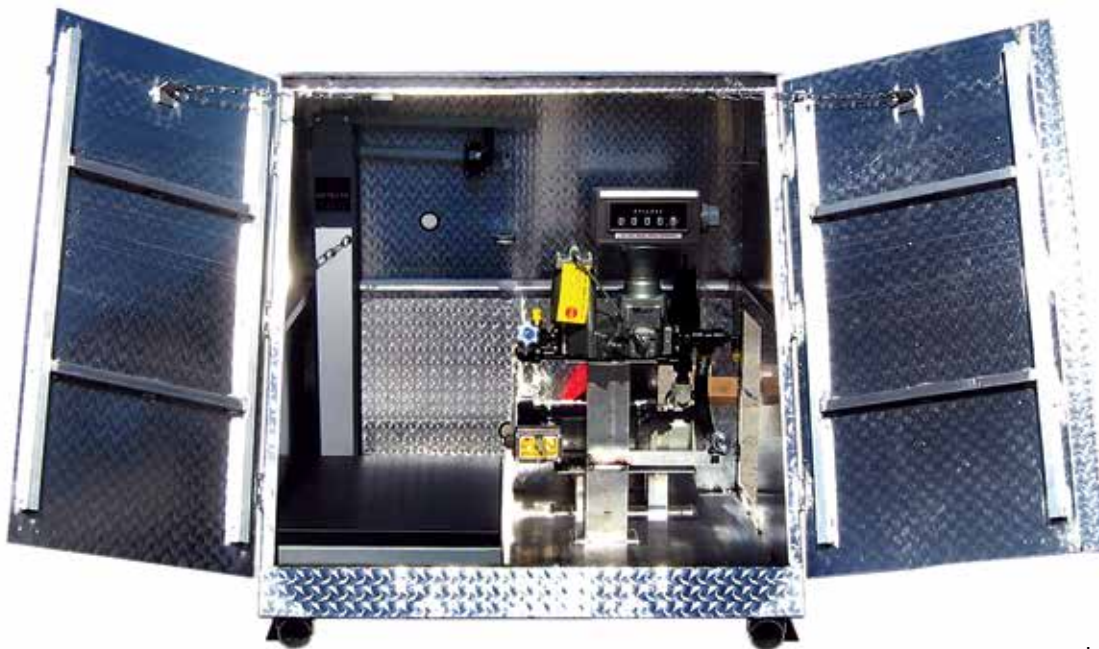

Pump Station Quote

Go to our website
and click "Pump Station Quote"
or
use the QR code
and get your quote today.



Aluminum Assembled Pump Station Cabinet - Electrical

D2A-KIT-ALUM-E

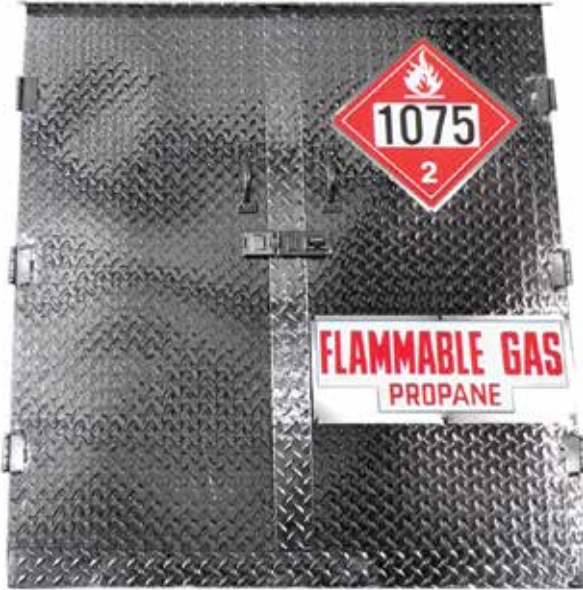

Components Include:

- Cabinet
- Pre-wired with Wall Mount Switch for 220V
- Exterior Junction Box for Electrical Connection
- Tank Stands (*not pictured*)
- Corken C12 Pump with Switch
- Bypass Valve
- Liqua-Tech Meter
- Scale (*Do not install wheels if placed in cabinet*)
- Piping Kit (*Internal Valve 1/4", Hydrostatic Relief Valve, Angle Valve 3/4", Excess Flow Valve 3/4", Y Strainer, Flex Connector, Forged Steel Fittings, Schedule 80 Nipples, 3/4" Breakaway Coupling*)



Pump Station Quote

Go to our website
and click "Pump Station Quote"
or
use the QR code
and get your quote today.



Aluminum Assembled Pump Station Compact Cabinet*

D1-KIT-ALUM



Corken pump shown.
Also available with a Smith Pump.



CLOSED VIEW

Components Include:

- Cabinet
- Tank Stands (not pictured)
- Corken C12 Pump with Switch
- Bypass Valve
- Liqua-Tech Meter
- Piping Kit (Internal Valve 1/4", Hydrostatic Relief Valve, Angle Valve 3/4", Excess Flow Valve 3/4", Y Strainer, Flex Connector, Forged Steel Fittings, Schedule 80 Nipples)

**This compact Pump Station does not include a scale.*

Propane AutoGas is domestically produced, safe for the environment, and affordably priced. Utilized in the school transportation industry since 1992, propane AutoGas retains its gas structure at normal atmospheric temperature and pressure. In turn, propane AutoGas does not spill, pool, or leave any residue. Propane AutoGas is safe, non-toxic, and non-poisonous.

Pump Station Quote

Go to our website
and click "Pump Station Quote"

or

use the QR code below
and get your quote today.





Aluminum Assembled Autogas - Small Fleet

D1-KIT-ALUM-AUTOGAS-FILTER C16

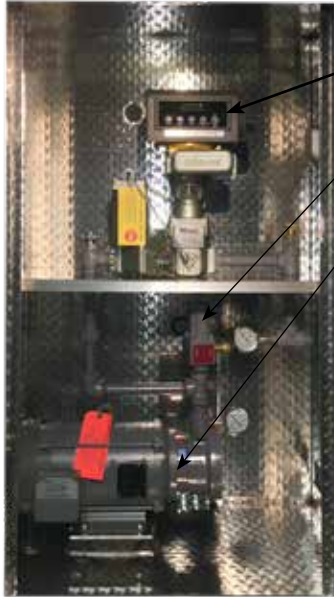

Diamond Plate
Aluminum Cabinet
#D-1-ALUM

Liqua-Tech 1" Mechanical Meter w/ATC
#090028-105

Corken B166 Bypass 100-225 psid
#B166-75CAU

Corken C16 Single Phase Pump
#C16MF6A

Need a Pump Station Quote?
Go to our website & click "Pump
Station Quote" in the navigation
or
use the QR code below and
get your quote today.



Optional:
Hose Retractor
with HoseBunn
#6102-1078P
and #PB-1394

Blue Moon Autogas
Filter #FST-634NS
(optional)

Nozzle Boot
#NBGG
(optional)

CLOSED VIEW

Aluminum Assembled Autogas - Medium Fleet

D3-MINI-SKID-KIT-AUTOGAS

- Aluminum D3 Cabinet
- Corken FF075 High Differential Pump & Bypass with 7.5hp 3ph Motor
- Flange Kit
- Liquid Controls MA5 Meter with ATC
- Veeder Root Mechanical Printing Register Head



- Blue Moon AutoGas Filter
- LG1E Dispensing Nozzle
- Hose Retractor and Hose Bunn with 3/4" Hose
- Auxillary 1/2" Cylinder Fill Hose (optional)

Pump Station Quote
Go to our website
and click "Pump Station Quote"
or
use the QR code below and
get your quote today.



SIDE VIEW



CLOSED VIEW



FST-634NS



Hose Retractor with Bunn

6102-1078P

Retractor Kit, vertical 78 inches Includes box, post, bracket, foot, and hardware



6102-1078P

PB-1394

Hose Clamp

1-1/8" outside diameter
3/4" inside diameter

FST-634NS

Blue Moon Autogas Filter

NB-GG

Gas Guard Nozzle Boot



NB-GG

ZVG2

Quick Connect
Autogas Nozzle

CAV 16-0331

Adapter

7194MD

Automatic Cylinder Filling



ZVG2

66-1327

Fill Valve for ZVG2



66-1327

Tank Stands

TS

Tank Stand Pair with
Meter Plate

TS-1

Tank Stand Pair
(no meter plate)

TS-HD

Tank Stand Pair
Heavy Duty 1800-1900

TPMP

Pump Plate

TST-1

Step

SUBSPP-1

Step

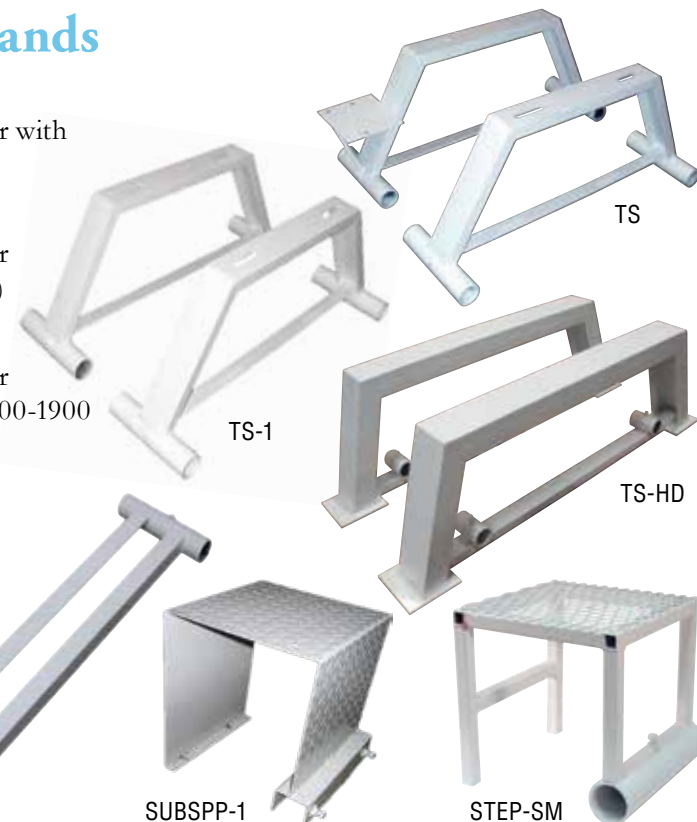

TPMP

SUBSPP-1

STEP-SM

Detecto Portable Platform Scales

854F100P

Height: 45"
Width: 24"
Depth: 35"
Platform height: 19"



Platform
width: 28"
Wheels:
Large 5"
diameter,

Heavy Duty Rubolene
Shipping Weight: 132lbs.
Max Capacity: 1000lbs.
Front of Beam: 100lbs.
x 0.5lbs.

*(Do not
install
wheels if
placed in
cabinet)*



Pump Station Hose



PS-HOSE

- Completed, assembled, and ready to use
- Dispenser hose 1/2" x 18 ft. with RegO Snap Valve and POL Fill Adapter.

Rego Quick-Acting Valves



7901TB

- For cylinder filling hoses
- 1/2" F.NPT inlet connection
- 1/4" F.NPT outlet connection

Rego Hose End Connectors

7193L-10A

- For filling forklift cylinders.



7193U-10

- For DOT cylinder filling hoses
- 1/4" M.NPT inlet connection
- FQCC outlet connection



7193D-10

- For filling DOT cylinders
- 1/4" M.NPT inlet connection
- M.POL CGA 510 outlet connection



POL Adapters

ME393HD

- Heavy duty forging
- Allows quick connection from QCC fill adapter to M.POL fill connector.
- Convenient hex for secure connection
- 15/16" M.ACME x SN swivel POL connection



MSCP-901H

- F.POL x 1 3/4" ACME adapter



5760A

- F.POL x 1/4" FPT



Fill Adapter for Gasmate II & Quick Disconnect Valve

F276329



Rego Adapter

7193T-10

- For filling DOT cylinders
- F.POL CGA 510 inlet connection
- Type 1 15/16" F.ACME outlet connection





Parker L.P. Gas Hose



Service: A flexible, heavy duty, and high pressure hose for the transfer of liquid or vapor propane or butane, in heater, torch, filling, delivery, and unloading applications.

Part Number	I.D. (in.)	Braid	O.D. (in.)	Approx.Wt. Per 100 Ft.	Max Recom. WP (PSI)	Ferrule Part #
LPH-1/4INDB	1/4	2	5/8	16	350	7327
LPH-3/8INDB	3/8	2	3/4	22	350	7332
LPH-1/2IN	1/2	2	15/16	31	350	
LPH-3/4IN	3/4	2	1 1/4	49	350	
LPH-1IN	1	2	1 1/2	61	350	
LPH-1 1/4IN	1 1/4	2	1 7/8	100	350	
LPH-1 1/2IN	1 1/2	3	2 5/32	110	350	
LPH-2IN	2	3	2 3/4	157	350	



**MALE PIPE MPT
X HOSE BARB**

Part Number	Hose ID	Thread Size
HC-4231	1/4"	1/8"
HC-4232	1/4"	1/4"
HC-4233	1/4"	3/8"
HC-4252	3/8"	1/4"
HC-4253	3/8"	3/8"
BG30 FE	3/8"	1/2"



**FEMALE NPT
by Hose Barb**

Part Number	Hose ID	Thread Size
HC-4631	1/4"	1/8"
HC-5632	1/4"	1/4"
BG-32EC	1/4"	3/8"
BG-32CE	3/8"	1/4"
BG-32EE	3/8"	3/8"
HC-4654	3/8"	1/2"



**MALE PIPE
by Hose Barb
High Pressure
Fittings**

Part Number	Hose ID
HC-5232	1/4" Male Pipe Thread x 1/4" Hose Barb
HC-5233	3/8" Male Pipe Thread x 1/4" Hose Barb

**MALE FLARE
by Hose Barb**



Part Number	Hose ID	Thread Size
HC-4835	1/4"	3/8" OD
HC-4855	3/8"	3/8" OD
HC-4857	3/8"	1/2" OD

**FEMALE FLARE
SWIVEL
by Hose Barb**



Part Number	Hose ID	Thread Size
HC-4335	1/4"	3/8" OD
HC-4355	3/8"	3/8" OD
HC-4357	3/8"	1/2" OD

**FEMALE FLARE
SWIVEL X HOSE
BARB
High Pressure Fit-
tings**



Part Number	Description
HC-5335	3/8" Female Flare Adapter x 1/4" ID Hose Barb
HC-5333	1/4" Female Flare Adapter x 1/4" ID Hose Barb



Corken Autogas Pump

Pump Only

Designed for high-pressure propane motor fueling. Three mounting options available. Direct drive with coupling, belt drive, and direct-mounted with C-face motor.

- Both pumps run with a three phase power source

Part Number	Flow Rate	Inlet	Outlet
FF075*	up to 40 GPM & 200 PSIG	1 1/2" ANSI 300#	1" ANSI 300#
FF150*	up to 58 GPM & 250 PSIG	1 1/2" ANSI 300#	1" ANSI 300#

*Flanges required for installation. Contact us with your specific requirements.

Pump & Motor

Designed for high-pressure propane motor fueling. Three mounting options available. Direct drive with coupling, belt drive, and direct-mounted with C-face motor.

- Both pumps run with a three phase power source



Part Number	Flow Rate	Inlet	Outlet
HDPFF075*	up to 40 GPM & 200 PSIG	1 1/2" ANSI 300#	1" ANSI 300#
HDPFF150*	up to 58 GPM & 250 PSIG	1 1/2" ANSI 300#	1" ANSI 300#

*Flanges required for installation. Contact us with your specific requirements.



Variable Frequency Drive (VFD)

A Variable Frequency Drive (VFD) converts the single phase of the FF060 & HDPFF-060 to a three phase power.

Part Number	Size
4204	15 hp
4204-1	10 hp
4204-2	20 hp



Corken C-Series Pump

Complete with Pump & Motor
Switch Sold Separately



C10 is ideal for single scale cylinder filling operations. Fill 20lb. cylinders in 30-45 seconds and a 100lb. cylinder in 2 1/2-3 minutes. The flow rate is 6.5 gallons per minute at 50PSID. C12 is ideal for faster filling operations including motor fuels. Rated at 15 gallons per minute at 50 PSI.

Part Number	Part Name	PH	Volt	Inlet	Outlet	GPM 50 PSI
C10FD6A	Pump & Motor	1	115/230	1 1/4"	1"	6.5
C12FD6A*	Pump	1	115/230	1 1/2"	1"	15
C13-B	Pump	1	115/230	1 1/2"	1"	22
C13-SM	Pump	1	115/230	1 1/2"	1"	22
C13-SM-B	Pump	1	115/230	1 1/2"	1"	22
C16MF6A	Pump	1	230/460	1 1/4"	1"	6.5
C16GD6A	Pump	3	230/460	1 1/4"	1"	6.5

Model	GPM	Max PSIG
C10	12*	80
C12	19*	85
C13	36*	110
C14	38*	125
C16	9.8	150

*20 PSID @ 3450 RPM

*C-12 used for general filling 20lb. - 42lb. cylinders and motor fuel cylinders
Recommend using C-12 with meter application

Part#	Part Name	Type
SM-30	Switch	Motor Mount
S-30	Switch	Wall Mount

Repair Kits

Pump	Seal Assembly	Impeller	Seal Housing	Motor Only	Starter Switch	Heater for Switch
C10/F10	113-CXA*	1003-0	1004-1X	2556	2275 (600-T0X5)	P28
C12/F12	113-CXA*	1003-2	1004-1X	2556**	2275** (600-T0X5)	P32**
				4261+	3784+	
C13/F13	113-CXA*	1003-3	1004-1X	4261		
C14/F14	113-CXA*	1003-4	1004-1X	2557		
C16	113-CXA	1003-6	1004-1X	2557^		
				4885^		

*Includes Case O-Ring (2-246A) and Case Clearance Shims (1014/1014-1)

**with 1 1/2 hp motor

+with 2 hp motor

^with 3 hp motor

Basic Valve & Nipple Kits

PK-BK

Includes safety internal valve, strainer, flex, nipples, pipe fittings, adapters and hoses to complete your pump station.

Meter Piping Kits

LCMK-01

All the extra valves and fittings to install a meter in your pump station system.

Corken Z3200



The Z-Series Coro-Valve® truck pumps are a new generation of truck pumps specifically designed to comply with the pumping requirements demanded by the LPG industry.

Pump Speed	Differential Pressure		Approximate Delivery on Propane		Break HP Required		Pump Torque Required	
	RPM	PSI (KPA)	GPM	(LPM)	BHP	(KW)	Ft Lbs	(KG/M)
750	50	(345)	112	(424)	6.2	(4.6)	43.4	(58.9)
750	100	(689)	99	(375)	9.9	(7.4)	69.3	(94.0)
650	50	(345)	95	(360)	5.2	(3.9)	42.0	(57.0)
650	100	(689)	84	(318)	8.2	(6.1)	66.3	(89.9)
600	50	(345)	86	(326)	5.0	(3.7)	41.3	(56.0)
600	100	(689)	76	(288)	7.8	(5.9)	64.8	(87.9)
500	50	(345)	70	(265)	3.8	(2.8)	39.9	(54.1)
500	100	(689)	62	(235)	5.8	(4.3)	60.9	(82.6)

Z4500



The Z4500 is a 4 inch stationary pump designed for transport loading and multiple bobtail loading applications. Rated up to 800 RPM.

Pump Speed	Differential Pressure		Approximate Delivery on Propane		Break HP Required		Pump Torque Required	
	RPM	PSI (BAR)	GPM	(LPM)	BHP	(KW)	Ft Lbs	(KG/M)
800	50	(3.4)	400	(1511)	13.3	(9.1)	88	(12.0)
800	100	(6.9)	360	(1360)	26.7	(19.7)	176	(24.3)
650	50	(3.4)	326	(1209)	10.8	(8.0)	87	(12.0)
650	100	(6.9)	283	(1070)	21.7	(16.1)	175	(24.2)
500	50	(3.4)	235	(888)	8.3	(6.2)	87	(12.0)
500	100	(6.9)	200	(756)	16.7	(12.4)	175	(24.2)

Z3500



The Z3500 is a 3 inch foot mount pump designed for stationary applications. Rated up to 800 RPM. Direct replacement for 3 inch Blackmer Pump.

Pump Speed	Differential Pressure		Approximate Delivery on Propane		Break HP Required		Pump Torque Required	
	RPM	PSI (BAR)	GPM	(LPM)	BHP	(KW)	Ft Lbs	(KG/M)
800	50	(3.4)	121	(460)	6.6	(4.9)	43.4	(6.0)
800	100	(6.9)	110	(420)	10.6	(7.9)	69.3	(9.6)
650	50	(3.4)	98	(371)	5.2	(3.9)	42	(5.8)
650	100	(6.9)	88	(333)	8.2	(6.1)	66.3	(9.2)
500	50	(3.4)	73	(276)	3.8	(2.8)	39.9	(5.5)
500	100	(6.9)	63	(238)	5.8	(4.3)	60.9	(8.4)



PUMPS

Repair and Rebuild Kits for Sliding Vane Pumps (LPG/NH₃)¹

Pump Model #	521E		1021E		Z2000, ZH2000, ZX2000, ZXH2000		Z3200, ZH3200		Z3500		Z4200, ZH4200, Z4500	
Repair Kit Part #	2904-X26		2906-X26		3193-X16		3195-X16		3195-X26		3197-X16	
Description	Part #	Qty	Part #	Qty	Part #	Qty	Part #	Qty	Part #	Qty	Part #	Qty
Mechanical Seal Assembly	1769-XRA6	2	1769-XRA6	2	4431-XA6	2	4431-XA6	2	6660-XA6	2	4464-XA6	2
Blade	1168-7	10	1308-9	10	4428	6	4232	6	3936	6	4448	6
Blade Driver	-	-	-	-	4262-X	3	4262-X	3	5554-X	6	4449-X	5
Shaft Bearing	2754-X	2	2754-X	2	2754-X	2	2754-X	2	2754-X	2	4460-X	2
Thrust Bearing	-	-	-	-	4432	2	4432	2	4432	2	4453	2
Thrust Bearing Mounting Ring	-	-	-	-	4435	2	4435	2	4435	2	4454	1
Sideplate	1163-2	2	1209-1	2	-	-	-	-	-	-	-	-
Grease Seal (Outer)	1358	2	1358	2	4441	2	4441	2	4441	2	4463	2
Grease Seal (Inner)	-	-	-	-	4438	2	4438	2	4438	2	4462	2
Case O-Ring (Buna-N)	2-261A	2	2-268A	2	2-261A	2	2-261A	2	2-268A	2	2-270A	2
Flange O-Ring (Buna-N)	2-234A	2	2-245A	2	2-231A	2	2-234A	2	2-245A	1	2-231A	2
Flange O-Ring (Buna-N)	-	-	2-249A	2	-	-	-	-	2-259A	1	2-234A	1
Relief Valve O-Ring (Buna-N)	2-224A	1	2-228A	1	2-224A	1	2-224A	1	2-228A	1	2-234A	1
Relief Valve O-Ring (Buna-N)	2-112A	1	2-112A	1	-	-	-	-	-	-	-	-
Shim (0.002)	-	-	-	-	4439	8	4439	8	4439	8	4458	8
Shim (0.010)	-	-	-	-	4439-1	2	4439-1	2	4439-1	2	4458-1	2
Shim (0.020)	-	-	-	-	4439-2	2	4439-2	2	4439-2	2	4458-2	2
Shaft Key	-	-	-	-	2270	1	2270	1	2270	1	4459	1

Rebuild Kits - Contains everything in the repair kits listed above plus the parts shown in the table below

Rebuild Kit Part #	No Kit ²		No Kit ²		3194-X16		3196-X16		3196-X26		3198-X16	
Cam	1162-2	1	1201-2	1	4414	1	4242	1	5539	1	4443	1
Sideplate	-	-	-	-	4427	2	4231	2	3935	2	4446	2

Full Rebuild Kit - Contains everything in the rebuild kits listed above plus the parts shown in the table below.

Rebuild Kit Part #	No Kit ²		No Kit ²		3194-X36		3196-X36		3196-X46		3198-X36	
Rotor Shaft Assembly	1166-1X1R	1	1208-1X1R	1	4430-X2R	1	4495-X2R	1	1208-1X6R	1	4444-X2R	1

Repair Kits for Reciprocating Compressors (LPG/NH₃)

Compressor Model #	91		291M		491M		691M		D/FD891M	
Repair Kit Part #	3549-X1		3550-X1		3551-X1		3552-X2		5578-X2A	
Description	Part #	Qty	Part #	Qty	Part #	Qty	Part #	Qty	Part #	Qty
Suction Valve Assembly	3483-1X	1	3483-1X	2	2532-1X	2	3948-2X	2	3856-2X	4
Discharge Valve Assembly	3485-X	1	3485-X	2	2439-X	2	3857-2X	2	3857-2X	4
Piston Ring	1772	3	1772	6	1773	6	1739	6	1739	8
Piston Ring Expander	1775	3	1775	6	1776	6	1740	6	1740	8
Packing Set (V-Ring)	1452-1X1	1	1452-1X1	2	1452-1X1	2	1725-2X	2	1725-2X	2
Packing Set (Segmented)	-	-	-	-	-	-	-	-	3810-1X	2
Connecting Rod Bearing (Pair)	1367	1	1367	2	1491	2	3542	2	3542	2
Gasket Set	2526-XA	1	1281-XA	1	1481-X6A	1	1744-X1A	1	3970-1XA	1
Oil Seal	3259	1	1278	1	4438	1	3526	1	3526	1
Oil Deflector Ring	-	-	-	-	-	-	-	-	1732	2

¹ All kits are furnished with Buna-N O-rings which are suitable for LPG and NH₃ applications

² For rebuild kits and full rebuild kits for 521E and 1021E pumps, purchase the repair kit listed above and the additional parts shown in this table.

**SMITH
PUMPS**

GC-1LZ-M
with an EM-5B Motor



DW-1Z-M
with an EM1-3B Motor



EG-1Z-M
with an EM1-3B Motor



GC-1LZ
with foot mount



with foot
mount

GC-1LZ-M



- Gear set easy to maintain without disturbing the mechanical shaft
- No service ball bearing with no load design
- Balanced gear configuration minimizes gear tooth contact
- Superseal Mechanical shaft seal assembly, built as a kit onto the pump shaft

Part Number	Description
DW-1Z	Pump 10 GPM, 3/4"
EG-1Z	Pump 10 GPM, 3/4"
EC-HZ	Pump 15 GPM, 1"
GC-1LZ	Pump 13 GPM, 3/4"
EM1-3B	Motor 1 HP, 3600 RPM
EM-5B	Motor 1.5 HP, 3600 RPM

**ASK ABOUT OUR SMITH PUMP
AUTOGAS PACKAGE**



EMERGENCY SHUT-OFF VALVES

Rego Emergency Shut-off Valves

Especially designed for installation in liquid or vapor transfer lines at LP-gas bulk plants to provide for quick shut off of liquid or vapor flow in the event of an accidental pull-away or hose rupture.

Part Number	Exclusively For Use With	Inlet and Outlet Connections	Liquid Flow Capacity At 10 PSIG Pressure Drop (GPM)
A6010	LP-gas	1 1/4" F./NPT	-
A6016	LP-gas	2" F.NPT	475 (LP-gas)
A6024	LP-gas	3" F.NPT	-

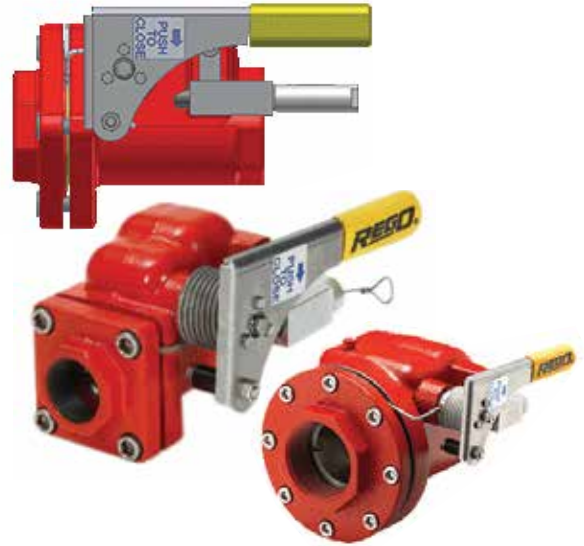

Rego Remote Cable Controls for Internal Valves

The 3200C Remote Cable Kit is designed especially for use with the 3200L Remote Operating Lever to operate internal valves from a remote location.



Part Number	Description	Contents
3200C	Remote Cable Kit	100 Foot Cable, 6 Cable Clamps, Quick Link, Sign, Fuse Link, Steel Nut and Bolt
3200L	Operating Lever	Lever Assembly
7606RM	Cable Release	Cable Release

Shut Off Signs

P-81

Pull to Close

P-82

Push to Close



P-81



P-82

ESV Pneumatic Controls

Part Number	Description
6016-60D	Cylinder assembly kit to convert 6016 ESVs to pneumatic shutdown.
6016-60C	Pneumatic remote for 6016. Open/close actuator
6016PN-50	Pneumatic remote shutdown system kit, complete with 100' of tubing, fittings, 1 charging valve assembly, and 1 remote shutdown assembly.
7605APN-8A	Extra shutdown valve assembly.
7605AP-16	1/4" tubing tee w/ nuts.
7605AP-15	1/8" NPT x 1/4" tubing, straight connector.



Designed for retail sales dispensing units, the Liqua-Tech Model LPM-102 offers the widest flow range (3-18gpm) available in a meter this size and contains all required accessories including vapor eliminator, strainer and differential valve. ATC available.

1" Meter 090534-100

Rate of Flow:

- 3.0 to 18.0 gpm

Working Pressure:

- 350 psi (24 bar) max. (24.6 Kg/cm²)

Connections:

- Standard assembly has inlet at left and outlet to right with 3/4" and 1" female pipe threads available.

Register:

- Veeder-Root, print or non-print
- Temperature Compensator:
- Compensates to 60°F (15°C)

Range:

- -10°F to 125°F
- -23°C to 52°C

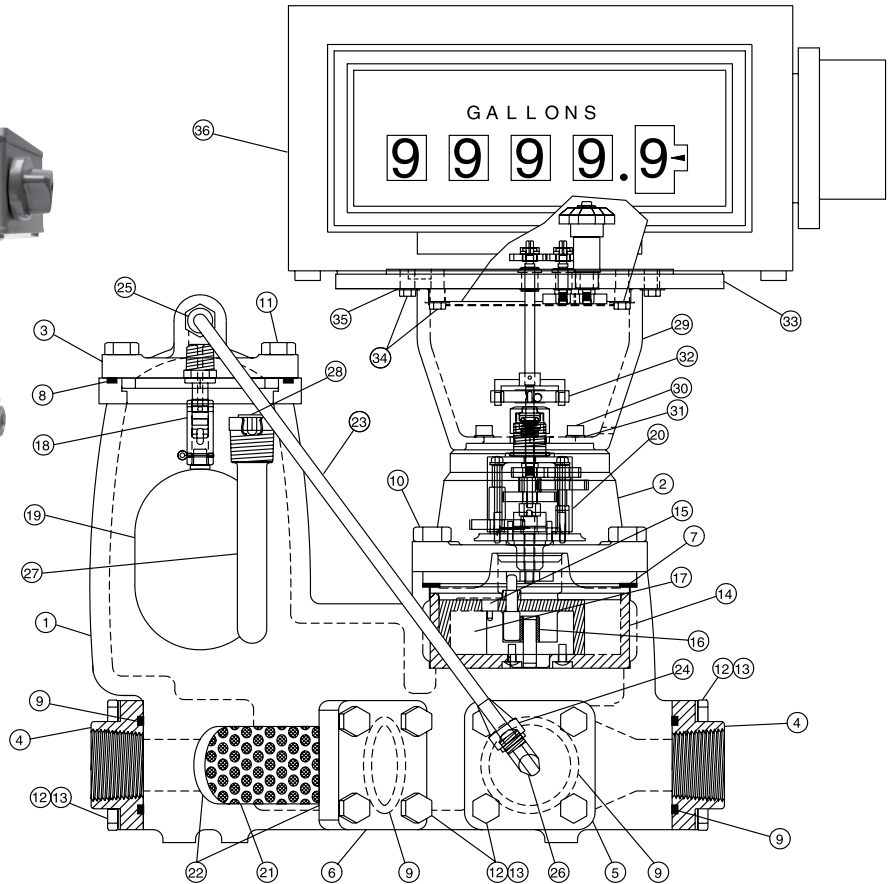

LPM - 102 w/rest register (w/o temp comp) complete		090534-100						
1	Main case housing	400027-00	13	Loackwasher, split 5/16	100121-010	27	Thermowell	086666-702
2	Cover, main case	087173-710	14	Measuring chamber	042075-101	28	Cover, thermowell	083732-000
3	Cover, vapor eliminator	087193-710	15	Seal pin	042792-000	29	Register adapter tower	886150-000
4	Flanges, inlet/outlet	087180-710	16	Roller, control	042086-010	30	Sockethead screws, 10-32 x 3/8	088524-010
5	Flange, differential valve	087179-710	17	Diaphragm	042791-000	31	Lock Washers, split #10	041211-000
6	Flange, strainer	400025-001	18	Vapor return valve	087190-000	32	Star Drive, with set screw	082976-001
7	Gasket, main case	004861-016	19	Float	087189-001	33	VRA-101-Register gear plate adapter (w/o Temperature comp)	886101-001
8	O-Ring, vapor eliminator flange	100139-012	20	Gear Train, 43.5 ratio, US Gal	080905-017		Cap screws, 1/4-28 x 5/8	
9	O-Ring, inlet/outlet flange	100139-007	21	Strainer 120 Mesh	101738-001	34	Drilled	100061-101
10	Bolt, Hex Head 7/16 x 1-1/4		22	O-Ring strainer end caps	100139-006		Undrilled	100061-100
	Drilled	040237-005	23	Tube assembly, vapor release	087196-001	35	Lock Washers, ext 1/4	100123-100
	Undrilled	040237-004	24	Nut, flared	087198-000		36	Register complete, Veeder Root (non printing)
11	Bolt, Hex Head 3/8 NC x 1	100067-027	25	Male connector 1/8 NPT x 1/4 Tube	084826-100			
12	Bolt, Hex Head 5/16 NC x 1	100063-26	26	900 Elbow, 1/8 NPT x 1/4 Tube	087195-000			

Liqua-Tech Mid-Com Meter

Liqua-Tech's LPM-102 equipped with Mid:Com's intrinsically safe E:Count LT Counter for established reliability, accuracy, and safety. This meter is also equipped with Liqua-Tech's Patented Trac-Bearing measuring chamber, for improved accuracy, reliability and lower maintenance. The Trac-Bearing design controls and stabilizes piston rotation more efficiently than standard control rollers, resulting in greater sustained linear accuracy with less wear.

With ATC: 090028-706



FEATURES AND BENEFITS OF ELECTRONIC REGISTRATION

- Multi-point calibration to improve the accuracy over a wide flow range
- Electronic Temperature Volume Compensation (ETVC) to reduce lost volume
- Increased security
- Future expansion and modularity with RS232/485 communication
- Greater control and accuracy of the delivery system through use of two stage valves, optical air eliminators with a LectroCount
- Register as a central control unit
- Lower total cost of ownership through fewer moving parts, solid state electronics and longer MTBF (Mean Time Between Failure).



Lectrocount LCR-II

Liquid Controls produces among the most reliable and accurate metering systems available, worldwide. For truck-mounted or fixed-site custody transfer applications requiring Weights & Measures approved accuracy, LC products deliver consistent, error-free, dependable service. Liquid Controls family of

LectroCount electronic registers provide:

- Improved efficiency relative to mechanical systems
- Electronic temperature compensation
- Weights & Measures approvals
- Ruggedness and reliability
- Simplicity of Operation
- Compatability with mobile computing solutions

Optional Air Eliminator + Optional Vapor Eliminator

MA-7-GY-10-LCR II



Liquid Control Meter

LC Meters are known worldwide for exceptional accuracy, reliability, and longevity in a broad range of applications including truck applications metering refined petroleum products and LPG.

Meter Registers

Part Number	Description
788700-002	Veeder Root Register Only
789002-002*	V.R. Register Printer-Face Up Ticket - Right Hand
100498-009	3/4" Neptune 631 (Code AEAAD)
100498-016	1" Neptune 631 (Code AAAAD)
880030-000	1 1/4-2" Neptune 833 (Code O)

*Factory rebuilt register available. Core return required.

Veeder Root Registers



788700-002



789002-002

Neptune Registers



600 SERIES



800 SERIES



Pump Out Adapters & Kit

VENTUR-EVAC

Pump Out Adaptor



VENTUR-EVAC HOSE KIT

Kit Includes:

(1 each): 3121, 3127U, 3175B, 7550P, 7590U-10, LPH-1/2X50P, LPH-3/4X50P, M498-4/2

(2 each): 3171A, 3175, 5765D, 600115, 600120, 80-104-01



HIGHLIGHTS OF THE VENTUR-EVAC

- Reduce Labor Costs: Tank evacuations can be performed by your delivery drivers while they are on their routes.
- Immediately remedy tank overfills: No more calling back to the shop to dispatch service personnel for costly pump outs or flare offs.
- Easily fix stuck backcheck valves: Closing one ball valve reverses the flow of liquid, immediately unseating the backcheck valve.
- Efficiency and Cost: One person, one truck operation reduces labor costs during tank evacuation
- Safe to operate: Eliminates the ignition hazard created by an engine driven compressor.
- Reliability: The absence of moving parts increases longevity over other evacuators on the market.

SG100-C

Comes with Sight Glass

1 3/4" M.ACME x 1 3/4" F. ACME



Multipurpose Valve

A8018DP

Part Number	Inlet Connection (M. NPT)	Outlet Connection (F. NPT)	Filling Connection (M.ACME)	Filling Capacity At 20 PSIG Pressure Drop GPM/NH3	Approximate Excess Flow Liquid Closing Flow GPM/NH3	Accessories	
						Hydrostatic Relief Valve	Vent Valve
A8018DP	1 1/4"	1"	1 3/4"	74	50	SS8001J	TSS3169

*Determined at 9 to 12 PSIG differential.

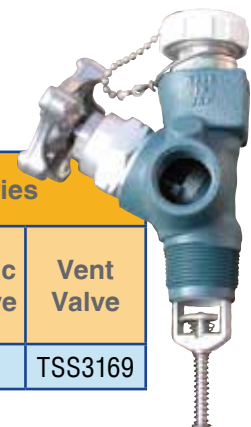



Smith Pump with Honda Gas Engine EG-1Z#7H



Krug Portable Compressor

H50LPH - Compressor with LP engine
H50GH - Compressor with gasoline engine
16771 - Compressor only (no engine)



Uses include on-site upgrading or downgrading size of storage in the field and emptying cylinders or tanks in need of repair.

Part Number	Qty	Description
LPH-1/2X18P	2	18ft. 1/2" hoses w/ends
LPH-3/4X40P	1	40ft. 3/4" hose w/ends
3171A	2	1 1/4" F.ACME x 1/2" MPT
7572C-14A	1	Check Loc Adapter 3/4"
3175	2	1 3/4" F.ACME x 3/4" MPT
7550P	1	Transfer Valve 3/4"
5765D	1	1 3/4" M.ACME x 3/4"
600120	1	Coupling SCH 80 3/4"
A7705P	1	Globe Valve 3/4" FPT
A7704P	2	Globe Valve 1/2" FPT
3175B	1	Coupling, 1 3/4" F.ACME x 1/2"

*Also available in natural gas and electric models.
Repair parts available as well.*

Compressors are extremely versatile as they can be used to transfer liquids between tanks, off-load liquids, recover residual vapor and evacuate vapors for cylinder maintenance.

Part #	Qty	Description
12 PLUG	1	3/4" NPT square head steel pipe plug for EG-1*
34 PLUG	1	3/4" NPT square head steel pipe plug for EC-H*
E-2	1	Gear end cover
3/8-16Tx1-1/2L	8	Short GR.5 cap screws for gear and cover
3/8-16Tx3-1/2L	4	Long GR.5 cap screws for mounting to spacers
6230-28	1	O-ring for gear end cover
EG-5	1	Drive gear for EG-1
EC-5H	1	Drive gear for EC-H
EG-6	1	Idler Gear w/ E-10 brushing for EG-1
EC-6H	1	Idler Gear w/ E-10 brushing for EC-H
EC-21	1	Strainer screen
568-118	1	Top O-ring
6227-17	1	Bottom o-ring
E-20ASSY	1	Bypass valve cartridge (includes o-rings)
E-1	1	Main housing for EG-1
E-1H	1	Main housing for EC-H
E-9	1	Idler Gear Shaft
105CUP	1	Leak detection port with bleeder cup
E-100	1	Shaft Seal Assembly for EG-1
E100[H	1	Shaft Seal Assembly for EC-H
E-15	1	Bearing Retainer Plate
10-32Tx1/2L	8	Fillister Head Screws for Bearing Retainer Plate
VC-20	1	Complete Drive Coupling (electric motor use) EG-1**
VC-30	1	Complete Drive Coupling (electric motor use) EC-H**
FD-20	1	Coupling Insert for EG-1
FD-30	1	Coupling Insert for EC-H
CG-E	1	Optional-Coupling Guard Screen
E-3	4	Mounting Spacers with Studs
E-52	1	Optional - Foot Mounting Bracket
R3-21	4	Spacers for Optional Foot Mount Bracket
5/16-24Tx1L	4	Gr.5 Cap Screws for Mounting Spacers
---	4	Threaded Holes for E-3 Mounting Spacers
E-51	1	Engine Adapter Plate



10 LB. Aluminum Vertical & Horizontal

9058TC.2
(vertical)

9059TC.1
(horizontal)
OPD/QCC



20 LB. GRAY Cylinder

10504.102
OPD/QCC
Steel
Black Cap
Pre-Purged



20 LB. White Cylinder

MSCP-10518VWZ
OPD/QCC
Zinc Metalized
Steel
Rust Resistant
Vacuum Purged



30 LB. White Cylinder

MSCP-1170VWZ
OPD/QCC
Zinc Metalized
Steel
Rust Resistant
Vacuum Purged



40 LB. White Cylinder

MSCP-1270VWZ
OPD/QCC
Zinc Metalized
Steel
Rust Resistant
Vacuum Purged



100 LB. Gray Cylinder

MSCP-1836VGZ
Multivalve
Zinc Metalized
Steel
Rust Resistant



POL Plug

737-5



Tank Cradles

*120 gal. to 350 gal. tanks need 1 strap and 2 anchors. 351 gal. tanks to 1500 gal. tanks require 2 straps and 4 anchors.

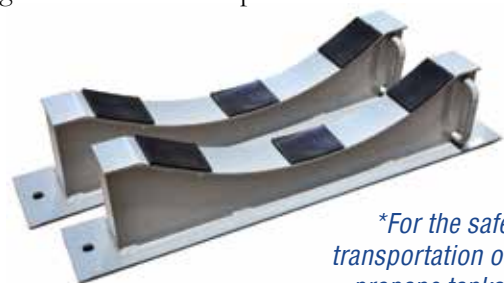

TC-1-A

**For the safe transportation of propane tanks.*



CYLINDERS AND STORAGE CABINETS

100 LB. ASME Cylinder

68143
Vacuum Purged
Plastic Lids



420 LB. ASME Cylinder

6762.8
Vacuum Purged
Plastic Lids



100 LB. Cylinder

1428
Steel
POL Adapter



33 LB. Aluminum

9315.52
Liquid with
fillvalve
with gauge
Quick coupler
installed



33 LB. Aluminum*

9367
Mower cylinder
Vapor withdrawal
Fuel efficient
& Green



33 LB. Steel Forklift Cylinder

5580
Liquid with gauge
Quick Fill Valve
Quick coupler
installer



**Other Sizes Available*

Protective Cap for QCC1

PPC3B



Dust Cap

DC-QCC1





20 LB. White Cylinder

MSCP-10518VWZ
OPD/QCC
Zinc Metalized Steel
Rust Resistant



33 LB. Steel Cylinder

MSCP-15580VGZ
Forklift cylinder
Gauge and fill valve 7141M
Code 12



20 LB. Cylinder Storage Cabinets

Powder coated white. Other colors available. Includes 3 safety decals and a place for a safety placard (placard not included).

Part Number	*Low Profile	Depth	Width	Height
X-12	12	27"	43"	50"
X-16	16	27"	60"	50"
X-18	18	27"	43"	72"
X-24	24	27"	60"	72"
X-24L	24*	27"	85"	50"
X-36	36	39"	50"	72"

*Low Profile

These heavy duty Gas Cylinder Cabinets are designed for outdoor storage using heavy gauge construction. If you're looking to keep your gas cylinders safe, choose either the X or M Series cabinets to store your tanks.

Features:

- Lockable T-handle plus hasp for padlock
- Tapered front shelf for easy cylinder placement
- Heavy duty tubular hinge welded to frame and door



33 LB. Cylinder Storage Cabinets

Painted safety yellow - rust inhibitor and includes 3 safety decals.

Part Number	Number of Cylinders	Depth	Width	Height
M-4	4	37"	30"	40"
M-6	6	37"	30"	55"
M-8	8	37"	30"	70"
M-12	12	37"	43"	70"
M-16	16	37"	60"	70"
M-24	24	37"	85"	70"

Construction:

- All welded construction. No nuts and bolts to come loose.
- 1 1/2" angle frame
- 1" angle shelves
- 16 gauge steel roof
- 16 gauge expanded metal sides and doors



TANK ANCHORING

Underground anchoring equipment for 500 and 1,000 gallon tanks. These are specifically designed to secure both 500 and 1,000 gallon Underground Tanks to a cement pad.

Minuteman Tank Anchoring System for Floodplain Tiedown

Part Number	Description	Use
1346	36" Earth Anchor w/4" & 6" Disks	Dense / Normal Soil
1593	36" Earth Anchor w/4" & 6" Disks & Stabilizer	Dense / Medium Soil
1284	50" Earth Anchor w/Double 4" Disks	Loose to Medium Soil
1284G	50" Earth Anchor Galvanized w/ Double 4" Disks	Loose to Medium Soil
2391	Dry Concrete Anchor w/Bolt Expansion Sleeve	Concrete - Dry
2010-MINUTE	Split Bolt and Nut	All Anchors
2365	Stainless Steel Sling w/Sheathed Strap & Seals	For Vertical Cylinders
2375	Stainless Steel Strap 100 ft. Roll	Cylinders
2382	Strap Sheathing - 150 feet	Cylinders
2730	Minute Man Drive Machine	Cylinders
2741	Minute Man Anchor Adapter	Cylinders



Underground Tank Kit

UG-Kit

Contains:

- (2) 1/2" x 15' cables
- (4) 1/2" x 6' turnbuckles
- (6) 1/2" cable clips
- (4) 1/2" x 9" x 15" anchors





Anode Test Kit

ATK-2

The anode test kit meets the requirements of NF-PA58's new standard for Cathodic Protection. Anode test includes: meter, instructions, half-cell, 12-foot lead with hippo clip, set of red & black adapters, and case.



Download Cathodic Protection Record Sheet at tarantin.com/downloads/Cathodic-Protection-Recording-Sheet.pdf

Riser Pipe Clamp

Retrofit anode connection for existing or new underground tanks.

Part Number:

RPC.1

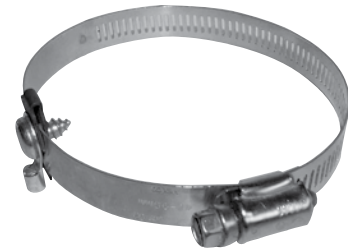

Magnesium Anode Bag

5, 9, and 17 lb. anode with 10 ft. X #12 gauge electrical lead attached. Bagged and boxed for shipping protection.

Part Numbers:

MG-5LB, MG-9LB, MG-17LB



Bracket Mounting Adapter

Optional accessory item for the anode test kit (ATK-2).

For use with telescoping extension pole (16281).

16285



Telescoping Extension Pole

Optional accessory item for the anode test kit (16285).

16281

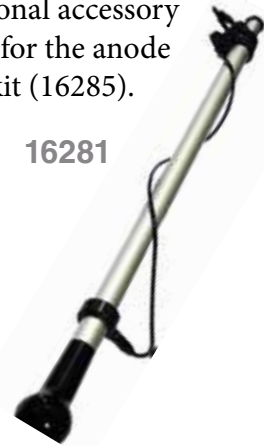

Copper Sulfate Crystals 12 oz.

16906

Optional accessory item for the anode test kit.



Copper Sulfate Crystals 1 lb. 3 oz.

T&R50300

Optional accessory item for the anode test kit.



Copper Sulfate Anti-Freeze

17105

Optional accessory item for the anode test kit.





PT9102 Series Service Valves

PT9102D11.1
PT9102D11.7

For vapor withdrawal service on DOT and ASME containers. They have an integral pressure relief valve and may only be used as an accessory valve on containers that have an independent pressure relief valve sufficient for that container's capacity.

- 3/4" M. NPT
- Service Connection F. POL CGA 510
- Fixed Liquid Level Vent Valve: Yes
- Approx. Filling Rate Liquid Flow GPM: Pressure drop across valve
- 10 PSIG: 7.6 | 25 PSIG: 11.7 | 50 PSIG: 15.2 | 100 PSIG: 20.6



Presto-Tap Gauges

6800
300 PSI Gauge

6800-B90
300 PSI Gauge with Bleeder Valve

PT-30LP
30 PSI Gauge with Bleeder Valve 90
Patented, liquid filled or dry 30 PSI/ ambient temperature gauge. The inner red dial is the temperature reading that should closely correspond to the pressure reading (outer black dial) if liquid is in tank. Quick adapter provides access to the Presto-Tap valve without tools. Cloth belt-loop holster is included. Also available with 10" hose to easily accommodate underground tanks.



PT7556R Multivalve

PT7556RS12.0

Suited for vapor withdrawal of ASME containers where compact groups of components are necessary. Separate filler valves and pressure relief valves are required.



Presto Tap Universal Service Tech Kit

Universal Service-Tech-Kit

This diagnostic and leak tech kit includes a 6800 kg gauge, a PT-30 kg gauge, PT-5 kg gauge, PT-OZ, MHA-Straight, universal flex hose, 3/16 allen key, RV, and bag.

Pigtails with Presto-Tap

PT912JS12
12" POL 1/4" M. NPT

PT912JS20
20" POL x
1/4" MPT



Pressure Tap with Block

MSCP-TRV-BLOCK
M.POL x F.POL high pressure test block (between tank and regulator).

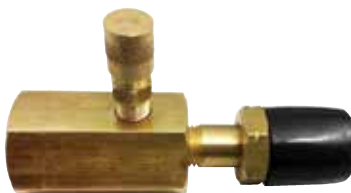

Test Adapter

MSCP-TRV
UL listed 1/8" M. NPT Regulator Valve for tank pressure and regulator tap location. Tank pressure, first stage and 11" w.c. locations. MSCP-TRV provides access for test instruments, either attached or by means of a hose barb.





Emergency Response Kit

ERK-1

A complete package in a special toolbox that improves your ability to respond to propane emergencies. It is recommended for placement with key personnel in your company so that emergency response time can be kept to a minimum.



High Pressure Test Block

2962

Test block M. POL x F. POL
0-300 PSI gauge and bleeder.



High Pressure Test Kit

HPTK-2

Provides for easy and accurate high pressure tests that conforms with gas check procedures.

High Pressure Test Assembly

For air testing of piping systems includes brass test block, 3/4" Female pipe, air valve, and cap and a high pressure gauge

test assembly block

Part Number	Range	Gauge
MSCP-HPTA-5	0-5	PSI
MSCP-HPTA-30	0-30	PSI
MSCP-HPTA-60	0-60	PSI
MSCP-HPTA-100	0-100	PSI



Low Pressure Test Kit

MSCP-LPTK

Includes pressure gauge, case, and 30" rubber tubing with bell end.



White Teflon Tape

ZT13

3/4" x 520" Roll
Standard Density

TT61

1/2" x 520" Roll
Medium Density

TT54

3/4" x 520" Roll
Medium Density



Yellow Tape

YT71

520" x 1/2" Roll

YT75

520" x 1" Roll

Wood Safety Plugs

WP3/4X12

3/4" x 12"

WP1-1/2X12

1 1/2" x 12"

WP2-1/2X12

2 1/2" x 12"

WP3-1/2X24

3 1/2" x 24"

WP4-1/2X24

4 1/2" x 24"

WP HOLDER

For 3/4" - 1 1/2" & 2 1/2" - Truck

In the event of a valve being sheared off, hammering in a wood safety plug will allow you to remove the tank to safe area.





Steel-Guard Paint



B54W151-1G
Tank, solar white, 1 Gal.

B54W151-5G
Tank, solar white, 5 Gal.

B50W24-1G

Kem bond white primer, 1 Gal.

B50W24-5G

Kem bond white primer, 5 Gal.



B71S200-1G
Bondplex, 1 Gal.

B71S200-5G
Bondplex, 5 Gal.

8538-1G

Silver gray, 1 Gal.

8538-5G

Silver gray, 5 Gal.

353-8-1G

Tarlon Mastic bottom guard for cylinders, 1 Gal.

Roskote R28 UG Tank Coating/Mastic

R28-1 1 Gal. **R28-5** 5 Gal.



NO. 11-1G

Thinner for use with 1 Gal. of mastic

For use on underground tanks.

1 Gal. will coat an entire 1,000 Gal. tank

Brushes

603-2

603-3

603-4



Bucket Grid

BG-1

For 5 gallon pail



The Original Saf-T-Lok

510
Lock

510-K
Key

1 key per box of 12 locks. Key can be sold separately.

Part Number	Description
510	POL-LOCK
510-K	POL-LOCK KEY

Locks

The easy to install 510 Saf-T-Lok securely locks POL service valves to prevent unauthorized hookups, reduce pilferage, and secures tanks after "out of gas" calls. Provides an effective credit control.



B531G



S502K-C-BLUE



B827P-A0



S533G-LLVC-A0

Part Number	Description
B531G & B827P-A0	POL Lock complete with lock and plug for LP outlet valve keyed alike (key not included)
S502K-C-BLUE	Key (when ordered with lock order) cut for each company
S533G-LLVC-A0	1 3/4" ACME valve cap lock with brass cap and slip ring with lock keyed alike (key not included)

Breakaway Locks

500BRK

Hidden breakaway feature allows fire department or emergency response personnel access to valves, plant gates, etc. Lock shackle breaks away when struck with a hammer or chisel. Keyed alike.



Locking Caps



MSCP-MLC-1

2 1/4" inside diameter, 1 1/2" bottom opening, 1 1/8" height, filler valve type



MSCP-MLC-S4

2 1/2" diameter, 1 3/8" bottom opening, 1" height, 100lb. valve type: Encloses ACME thread or handwheel on valve to prevent tampering.

Roller Frame & Roller



7411

7312-9

Paint Tray & Liner

7645





Winter Tuf-Duk Glove

Foam insulated fit and flexibility for non-slip handling of cylinders and for driving.

31-791T-M
Medium



Leather Palm Glove

NO.1

Packed 12 pairs per case
General duty protective leather glove. Tuff stretch design. One size fits all.



Hydrex Gloves

11-435-09 (M) & 11-435-10 (LG)

Stay Cool in any work environment with Hydrex® nitrile exam gloves. Hydrex® inner coating helps absorb moisture and keeps you cool during extended wear. These gloves give you cut protection and are suitable in work environments where there is possible contact with bodily fluids, microorganisms, and chemicals.



Edmont Raised Finish Monkey Grip Glove

23-173

Raised finish

Provides excellent grip for easier, safer handling of wet and dry materials. Tough vinyl coating resists chemicals and abrasion. Comfortable non-woven lining to keep wetness on the outside and dryness on the inside.



23-173

Sherlock 5-Second Leak Detector

300-L32

1 Pint Empty
Brush Top

800-LS3

1 Pint Empty
Spray Bottle

800-LS5

1 Gallon Low Temp Jug

Ideal for use with pressurized gas systems. Ultra-sensitive to low pressure, minute leaks. Retains bubbles; bubble size indicates leak rate. Safe for use on polyethylene pipe fittings as outlined in ASTM test D-1693. Service temperature range: -10 ° F to 160 ° F. Wettable: fluid stays on metal longer, it can be used on vertical surfaces.



pictured in order of listing

Disposable Gloves

93-250

Extra Large.
100 Gloves in a box. 10 Boxes in a carton. Black and Powder free.



Safety Treads/Ice Cleats

SGT-1

Size 8-11 Spiked

SGC-1M

Size 5-9 Coiled

SGT-2

Size 11-13 Spiked

SGC-2L

Size 9-12 Coiled

SS-2XL

Size 13+ All Purpose

SGC-3XL

Size 12+ Coiled



SGC pictured

Strap onto your work boot for sure footing on any surface. Easy-on tough rubber material.

Bee Bopper

Beebop-Case

Wasp and Hornet spray
12 - 14 oz. cans per case



Halt! Dog Repellent

Halt-Case

12 - 1 1/2 oz. cans per case. Complete with belt clip.





Steel Case Pressure Gauges

2" industry standard single scale dial PSI ranges, steel painted black enamel bezel and case, clear glass lens, brass movement, phosphor or bronze bourdon tube

1/8" NPT Connection

Part Number	Range	Gauge
MSCP-SG2-15 1/8	0-15	PSI

Bottom Mounted 2" x 1/4" Bottom Connection

Part Number	Range	Gauge
MSCP-SG2-15	0-15	PSI
MSCP-SG2-30	0-30	PSI
MSCP-SG2-60	0-60	PSI
MSCP-SG2-100	0-100	PSI
MSCP-SG2-200	0-200	PSI
MSCP-SG2-300	0-300	PSI
MSCP-SG2-400	0-400	PSI

Back Mounted 2" x 1/4" Back Connection

Part Number	Range	Gauge
MSCP-SGC2-15	0-15	PSI
MSCP-SGC2-30	0-30	PSI
MSCP-SGC2-60	0-60	PSI
MSCP-SGC2-100	0-100	PSI
MSCP-SGC2-200	0-200	PSI
MSCP-SGC2-300	0-300	PSI
MSCP-SGC2-400	0-400	PSI



Brass Case Pressure Gauges

2" single scale dial, PSI Ranges, glossy brass case with screw-on bezel, clear glass lens, brass movement, phosphor or bronze bourdon tube

1/8" NPT Connection

Part Number	Range	Gauge
MSCP-BG2-300 1/8	0-300	PSI

Bottom Mounted 2" x 1/4" Bottom Connection

Part Number	Range	Gauge
MSCP-BG2-15	0-15	PSI
MSCP-BG2-30	0-30	PSI
MSCP-BG2-60	0-60	PSI
MSCP-BG2-100	0-100	PSI
MSCP-BG2-300	0-300	PSI
MSCP-BG2-400	0-400	PSI

Back Mounted 2" x 1/4" Back Connection

Part Number	Range	Gauge
MSCP-BGC2-15	0-15	PSI
MSCP-BGC2-30	0-30	PSI
MSCP-BGC2-60	0-60	PSI
MSCP-BGC2-100	0-100	PSI
MSCP-BGC2-300	0-300	PSI
MSCP-BGC2-400	0-400	PSI

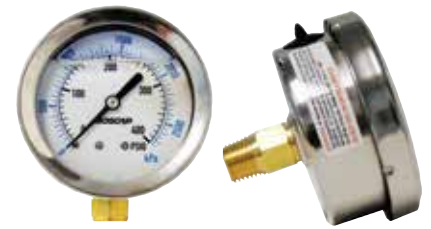

Liquid Filled Gauges

Glycerin liquid filled, stainless steel case, industry standard PSI/KPA dual scale readings, 2 1/2" dial range

Bottom Mounted 2 1/2" x 1/4" Bottom Connection

Part Number	Range	Gauge
MSCP-SGL2.5-30	0-30	PSI
MSCP-SGL2.5-300	0-300	PSI
MSCP-SGL2.5-400	0-400	PSI

Back Mounted 2 1/2" x 1/4" Back Connection

Part Number	Range	Gauge
MSCP-SGCL2.5-300	0-300	PSI
MSCP-SGCL2.5-400	0-400	PSI

Steel Case Pressure Gauges 4 1/4"

Standard single scale dial with PSI ranges, steel black case, phosphor or bronze bourdon tube



Test Assembly Block

Part Number	Range	Gauge
MSCP-SG4.5-300	0-300	PSI
MSCP-SG4.5-400	0-400	PSI



Hose Assemblies

Comes with quick disconnect



Part Number	Length	Diameter	Connection	Max PSI
556#1791	12 feet	1/2"	1/2" F. Flare	1/2 PSI (vapor only)
556#1793	12 feet	3/8"	3/8" F. Flare	1/2 PSI (vapor only)

Replacement Hose and Regulators

Part Number	Length	Connection
150-I5LTC24GRQC	24"	3/8" F. Flare x FQCC
150-I5LTC36GRQC	36"	3/8" F. Flare x FQCC
150-I5LTC60GRQC	60"	3/8" F. Flare x FQCC



UL and CSA Listed Hose Assemblies

Thermoplastic hose assemblies are available in 1/4" and 3/8" ID sizes only. The hose has a working pressure of 350 PSI with a 1750 PSI burst rating. All assemblies up to 60 inches in length are dual (UL and CSA) listed.



Part Number	Length	Connection	Diameter
42413-120	120"	3/8" F. Flare x 3/8" F. Flare	1/4"
42610-48	48"	3/8" M. MPT x 3/8" F. Flare	3/8"
42613-60	60"	3/8" F. Flare x 3/8" F. Flare	3/8"
42613-120	120"	3/8" F. Flare x 3/8" F. Flare	3/8"

Adapter Hoses

The 40407 adapter hose has a safe, convenient, and user friendly design that makes it ideal for hooking up portable and high pressure appliances such as camp stoves, lanterns, and table top grills to large cylinders.



Part Number	Length	Connection	Diameter
40407-48	48"	1"-20m x POL	1/4"
40407-60	60"	1"-20m x POL	1/4"
40402-24	24"	1/4" INVFL x POL	1/4"
40402-48	48"	1/4" INVFL x POL	1/4"



Rego Quick Acting, Minimum Loss Hose End Valves for Bobtail Delivery Trucks and Dispensing Stations

Loss at disconnect is now less than 2CC
Designed to vastly reduce the amount of product vented when disconnecting bobtail delivery trucks, dispensing systems, and anhydrous ammonia nurse tanks.

Part Number	Inlet Connection (F. NPT)	Outlet Connection (F. ACME)	Locking Handle	Flow at 1 PSIG (CV) Pressure Drop* (GPM/Propane)
A7793A	3/4"	1 3/4"	yes	16.0
A7797A	1"	1 3/4"	yes	16.0

Hose End Swivels

Part Number	Inlet-Outlet	Description	Make
JO-1	1" M. NPT	Swivel connector	Full Circle



Parker Bobtail Hoses

- Textured Covered and tested
- MPT Ends

LPH-1INX125P-T – 1 inch x 125 feet

LPH-1INX150P-T – 1 inch x 150 feet



Fairview Bobtail Hoses

- Smooth covered and tested
- MPT Ends

I16C1500MP16MP16 – 1 inch x 125 feet

I16C1800MP16MP16 – 1 inch x 150 feet





White Vinyl Warning

AA-16

Printed red and black,
Min. order of 100

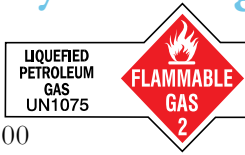

White Vinyl Custom Company Name

A-16

Printed red and black,
Minimum order of 3,500

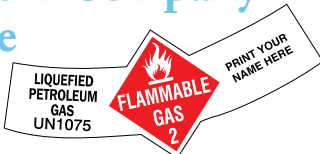

Propane Fill

M-97A

2' x 4', Single Face

M-97A-D

2' x 4', Double Face

M-97B

3' x 6',
Single Face

M-97-BD 3' x 6',
Double Face



Propane Exchange Single Face

M-93AX 2' x 4'

LP Gas Vinyl

V-1075



Sign Frames

SF-1 2' x 4', Frame ground style

M-97A-D

2' x 4',
Frame floor style comes with hardware

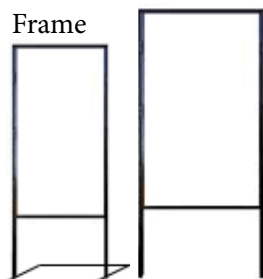

NFPA Hazard Rating

HZ-116

2 1/2" x 5", Printed blue, yellow, black, and red
Also available as HZ-116-GHS

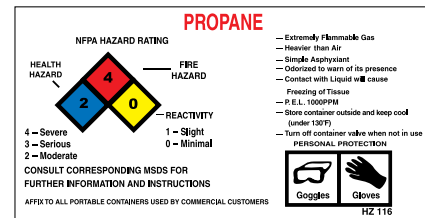

Recommended Procedures for Filling

V-206 14" x 21 1/4"
White printed Red

P-206

14" x 21 1/4" Blue
printed Red



No Smoking

V-23BB

22" x 4",
Printed Red



Sign Kit

SIGN KIT

Includes:

- S35483 - OPD Poster
- NFPA-704B - Warning Decal
- V-28C - Propane Sign
- V-17B - Flammable Sign
- V-23C - No Smoking Sign
- V-206 - Filling Procedures

Propane

V-28BB 14"

x 4", Printed
Red



DOT Cylinder Label Warning



CS33 2 1/2" x 5 1/2", White vinyl printed in Red, Blue, & Black

CS-33-GHS 2 1/2" x 5 1/2"
Custom printed with customer's name, address, and phone number

No Smoking

V-26B 12"

x 18", Printed Red



M-26B 12"

x 18", Metal printed Red

Custom Punch Card

5-C163-

BLANK

Available

as custom print with customers's RIN number

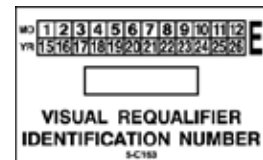

White Vinyl Bilingual Warning



AA-16-BI

Printed red and black
Minimum order of 100

Metal Gate Sign

M632 27" x 5", Printed Red





Renaldo Tank Carrier

EZTC717

Hydro Drive
Motorized
For Any Size ASME Tank
up to 1,000 Gallons



Renaldo Motorized Dolly

RTC420NG3

Gear Drive
3 Speed Honda Engine
Up to 420#



Renaldo Muscleman Hand Truck

RTC420M2

Manual
Split Handle



Renaldo Hand Truck

RTC33-SCOOP

For 33# Cylinders
Top Stacking



Hand Truck

HT7-900-4P

Up to 420# Cylinders



Tarantin App

INDUSTRIES, INC.

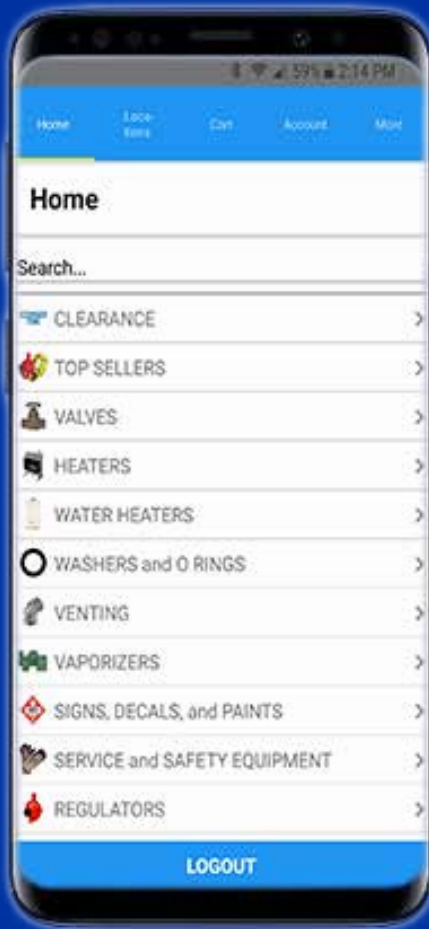

Ease of Ordering

Order parts In the field, in your warehouse, or anywhere! The app is tied into our parts database. **If you can find it on our website you can find it in our app.**

Warehouse Directions

Click on the address of the branch you're picking the parts up from and you're led to Google Maps.

My Account on the Go

Away from your office? Want to see your past orders or invoices? Have all of that information at your fingertips no matter where you are.

Download Our App - Order Wherever You Are



***or search "Tarantin"
GooglePlay or iTunes***

CORPORATE HEADQUARTERS

1 New Jersey Branch

86 Vanderveer Road
Freehold, NJ 07728
Fx: 732 780 5173

BRANCH LOCATIONS

2 New Hampshire Branch

20 Commercial Drive
Brentwood, NH 03833
Fx: 603 679 4605

3 Pennsylvania Branch

30 Industrial Road
Elizabethtown, PA 17022
Fx: 717 361 0370

4 Virginia Branch

9733 Coach Road
Richmond, VA 23237
Fx: 804 279 0206

5 Alabama Branch

240 Oxmoor Court, Suite 268
Birmingham, AL 35209
Fx: 877 769 1222

6 Florida Branch

5050 State Road 206 West
Elkton, FL 32033
Fx: 904 692 1068



Toll Free: 800 922 0724



Download Our App
Order From Anywhere

